

Polos

design by Landa R&D

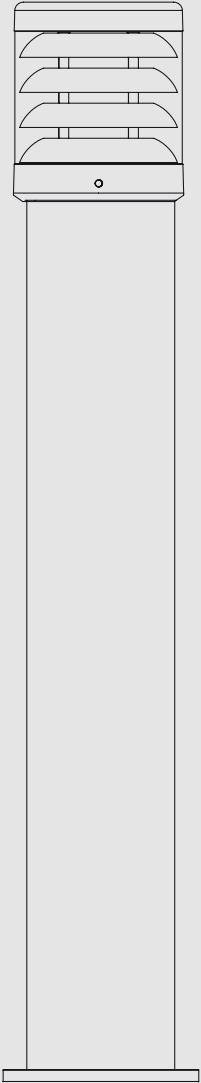

WALL LAMP



BOLLARD

EN Polos is the ideal product for lighting public and private outdoor spaces. A pole with a minimal and essential aesthetics, a synthesis of light and form. The body is made of EN47100 die-cast and AW6060 extruded aluminium, in the bollard version it reaches a height of 92 cm, available in Graphite, Grey and Oxide finishes. Functional, essential, Polos is excellent and resistant even in particularly extreme outdoor settings. Also available in a wall-mounted version.

IT Polos è il prodotto ideale per l'illuminazione di spazi esterni pubblici e privati. Un palo dall'estetica minimale ed essenziale, una sintesi di luce e forma. Il corpo è in alluminio pressofuso EN47100 ed estruso AW6060, nella versione bollard, raggiunge un'altezza di 92 cm, disponibile con finiture di color Grafite, Grigio e Ossido. Funzionale, essenziale, Polos è ottimo e resistente anche in ambientazioni outdoor particolarmente estreme. Disponibile anche la versione a parete.

Polos_1

IP64 IP65 EAC CE
wall bollard

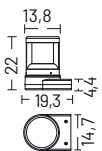

upwards wall lamp
cod. 10

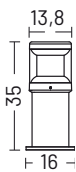

bollard
cod. 035



bollard
cod. 070





bollard
cod. 090

MATERIALS

Body	Die-cast aluminium EN47100 and extruded aluminium AW6060
Diffuser	Transparent polycarbonate
Finishing	Polyester powder paint

ORDER CODE

WALL LAMP BOLLARD		
4032	<i>Finishing</i>	H Grey 
		L Graphite 
		V Oxide 
	<i>Installation</i>	10 Upwards wall lamp
		035 Bollard h. 35 cm
		070 Bollard h. 67 cm
		090 Bollard h. 92 cm
	<i>Diffuser</i>	. Transparent
	<i>Example</i>	4032 . 070 V

ELECTRIFICATION

Bulb	Base type	Max wattage	Bulb dimension
	E27	LED 25 W	Ø 6 x 15cm

AVAILABLE ACCESSORIES

Code	Description	Page
00A405	Root Mounting Kit h. 47 cm	177
00A405.01P	Anchor bolt	177
0404M003	Loop in loop out IP68	176
0404M004	Single connection IP68	176



Polos_2

IP64	IP65	ERC	CE
wall	bollard		

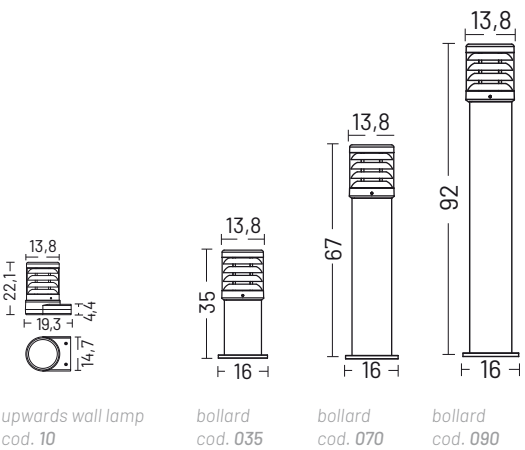



MATERIALS

Body	Die-cast aluminium EN47100 and extruded aluminium AW6060
Diffuser	Transparent polycarbonate
Finishing	Polyester powder paint

ORDER CODE

WALL LAMP | BOLLARD

4022	Finishing	H	Grey	
		L	Graphite	
		V	Oxide	
	Installation	10	Upwards wall lamp	
		035	Bollard h. 35 cm	
		070	Bollard h. 67 cm	
		090	Bollard h. 92 cm	
	Diffuser	.	Transparent	

Example 4022 . 035 V

ELECTRIFICATION

Bulb	Base type	Max wattage	Bulb dimension
	E27	LED 25 W	Ø 6 x 15cm

AVAILABLE ACCESSORIES

Code	Description	Page
00A405	Root Mounting Kit h. 47 cm	177
00A405.01P	Anchor bolt	177
0404M003	Loop in loop out IP68	176
0404M004	Single connection IP68	176

